

# SMT 7000 TS J

## Thru Beam

Photoelectric Sensors

### Compatible Receivers:

SMR 7607 TS J

SMR 7620 TS J

SMR 7707 TS J

SMR 7720 TS J



Product Data	
Function	Transmitter
Operation Mode	Thru Beam
Supply Voltage	10 - 30 V dc
Control Feature	Test input
Connection	4 pin, M12 plug
Sensing Range	20 m
Light Source	Infrared (880 nm)
Housing Material	Stainless Steel
Housing	M18 x 1

Technical Data	
Supply Voltage	10 - 30 V dc
Voltage Ripple	15 %
Reverse Polarity Protected	Yes
Current Consumption	25 mA
Test Input	Yes
Power On Indicator	Green LED
Light Source	Infrared (880 nm)
Emission Angle	+/- 2°
Housing Material, Front Lens	Polycarbonate
Housing Material, Sensor Housing	Stainless Steel (AISI 316 / 1.4401)
Cable	3 x 0,14 mm <sup>2</sup>
Cable Sleeve	PVC Ø 4,0 mm

Environmental Data	
Vibration	10 - 55 Hz, 0,5 mm
Shock	30 g
Operation Temperature	-20 to +60 °C

Storage Temperature	-40 to +80 °C
Sealing Class	IP 67

**Approvals**

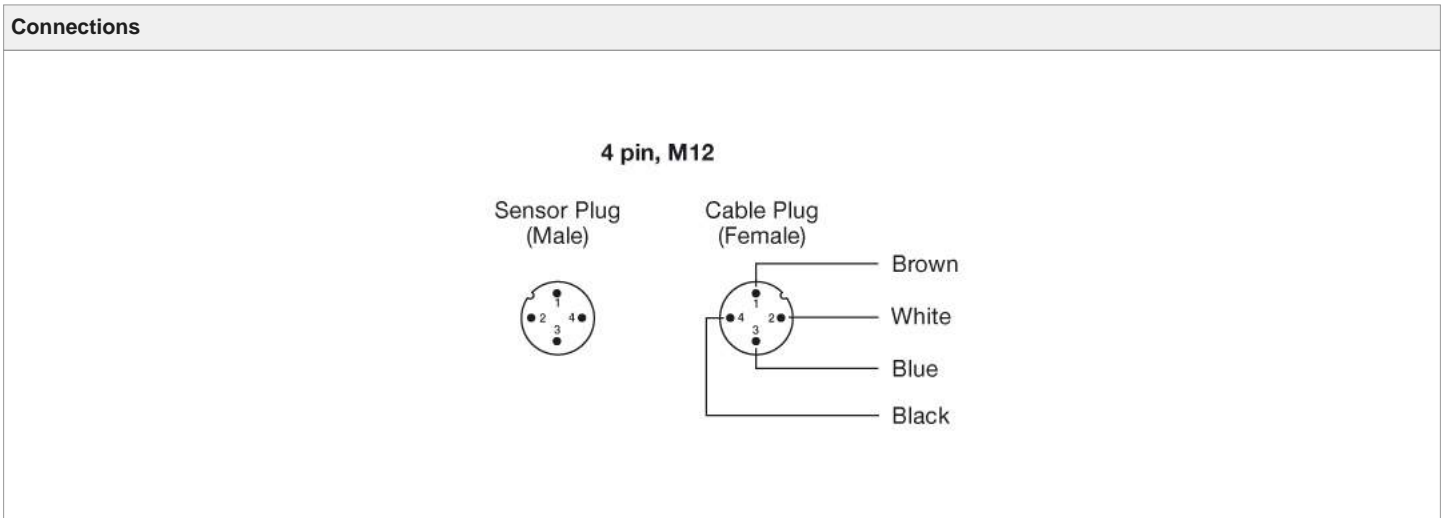
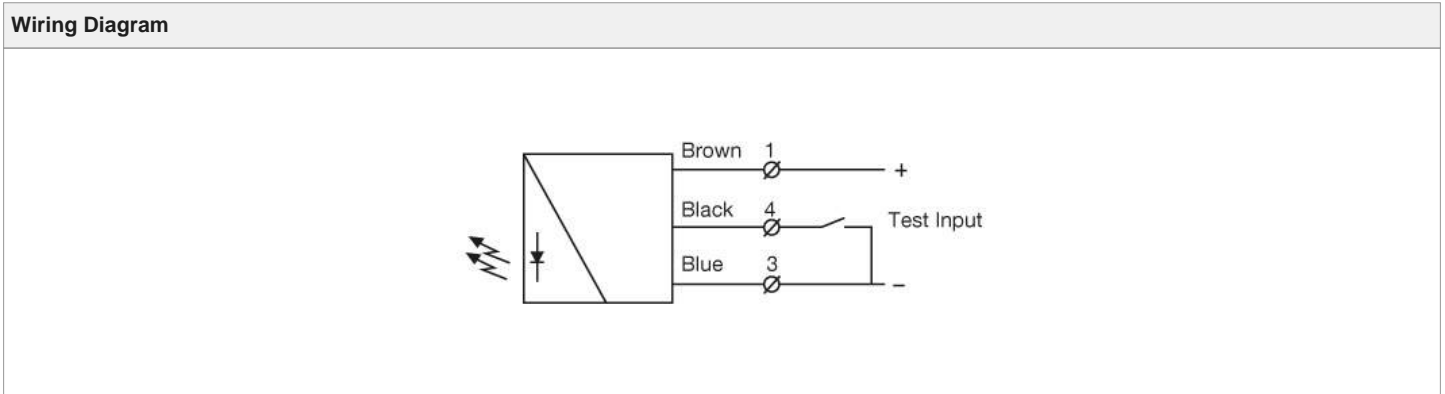
Parallel Displacement

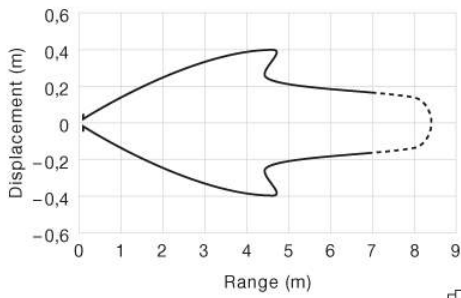

SMT 7000 and SMR 7x07

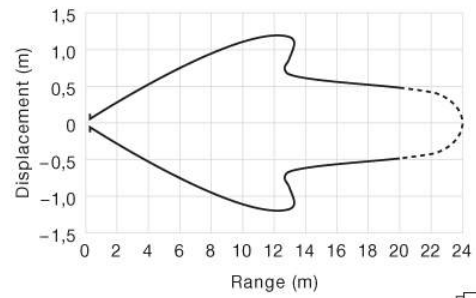
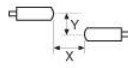

SMT 7000 and SMR 7x20

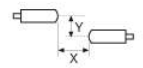

Angular Displacement

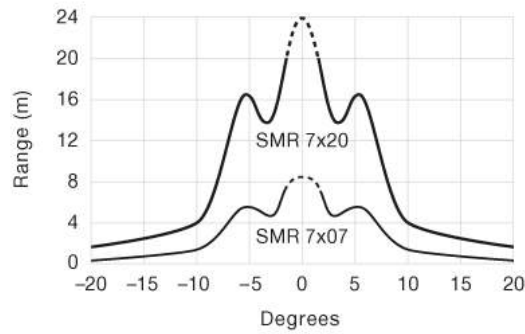

SMT 7000



Dimensions

