

Description

- 0-10 metre sensing range
- 4 to 384 channels (parallel beams)
- 10 to 1150 cross scanning beams
- Active length of 65 mm to 1920 mm
- Housing length of 160 mm to 1980 mm
- Plug connection
- Automatic sensitivity adjustment
- Parallel or cross beam selection via control input
- Blanking function
- 33x36 mm aluminium housing with T-slot mounting
- High tolerance to hostile environments
- Power, output and system status indicators
- 12-30 V dc supply voltage
- Solid state relay output
- High switching frequency

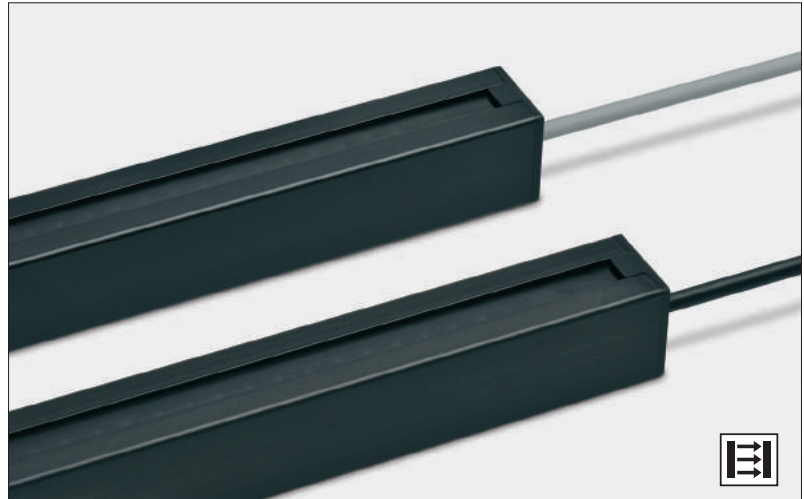

The SS 01 series is a light curtain system which consists of a self-contained transmitter SST and receiver SSR, which are to be positioned opposite of each other. The light curtains are housed in a sturdy aluminium profile (33 x 36 mm) with T-slot mounting rail, available in lengths ranging from 160 mm to 1980 mm.

The series is available with a 12-30 V dc supply voltage with a solid state relay output. The system is configurable to operate with either parallel or cross scanning beams which is selectable via a control input in the SSR. The SS 01 series features beam blanking function which is configurable using a second control input in the SSR to memorise the beams which are obstructed for up to 5 seconds during set-up.

A test input in the SST may be used for either disabling or enabling the transmitting power temporarily for test purposes.

The advanced automatic sensitivity adjustment ensures that no onsite set up or adjustments are required. The signal level of each individual channel is adjusted automatically, which compensates for misalignment and contamination during operation. The transmitter and receiver are electrically synchronised by wire connection. The system is intended for static applications.

Both the transmitter and receiver units are protected against reverse polarity of power supplies, control inputs and output signals. The output is also protected against short circuit and inductive loads.

Technical Data								
		SST			SSR			
Supply voltage		12-30 V dc						
Current consumption		100 mA			50 mA			
Output		-			Solid State Relay			
Output rating		-			200 mA			
Short circuit protected		-			Yes			
Reverse polarity protected		-			Yes			
Light source		Infrared (880 nm)			-			
Channel spacing		5 mm	10 mm	20 mm	5 mm	10 mm	20 mm	
Number of channels (diodes per detector)		16 ... 384	8 ... 192	4 ... 96	16 ... 384	8 ... 192	4 ... 96	
Number of beams		Parallel	8 ... 192	4 ... 96	16 ... 384	8 ... 192	4 ... 96	
		Cross	46 ... 1150	22 ... 574	10 ... 286	46 ... 1150	22 ... 574	10 ... 286
Active length		65 ... 1920 mm						
Housing length		160 ... 1980 mm						
Max. response time		Parallel / Cross	-			(N x 120 µs) + 2 ms		
		Parallel	-			6,6 ... 48,1 ms	6,6 ... 25,0 ms	6,6 ... 13,5 ms
		Cross	-			6,6 ... 140,0 ms	6,6 ... 70,9 ms	6,6 ... 36,3 ms
Power on indicator		Green LED						
Output indicator		-			Yellow LED			
System status indicator		-			Red LED			
Blanking function		-			Configurable			
Housing dimensions (w x d)		33 x 36 mm						
Housing material		Aluminium (black anodised)						
		CoPET						
Connection Cable, PVC Ø 5,9 mm		0,5 m cable with 5 pin, M12 plug			0,5 m cable with 8 pin, M12 plug			

Note: "N" is equal to the number of beams (parallel or crossed).

Environmental Data

	SST	SSR
Vibration	10-55 Hz, 0,5 mm	
Shock	30 g	
Light immunity @ 5° incidence	-	100 000 lux
Temperature, operation	-30 to +60 °C	
Temperature, storage	-40 to +80 °C	
Sealing class	IP 67	
Approvals	CE	

Available Types

	Housing Length	Active Length	Number of Channels	Number of Beams Parallel / Cross	Channel Spacing	Connection		0.5 m cable with 5 pin, M12 plug Order Reference	Range			
						Output						
Transmitter	160 mm	80 mm	16	16 / 46	5 mm	-	-	SST 01-10-016-016-05-H-1D1-0.5-J5	10 m			
	220 mm	160 mm	32	32 / 94				SST 01-10-022-032-05-H-1D1-0.5-J5				
	300 mm	240 mm	48	48 / 142				SST 01-10-030-048-05-H-1D1-0.5-J5				
	380 mm	320 mm	64	64 / 190				SST 01-10-038-064-05-H-1D1-0.5-J5				
	460 mm	400 mm	80	80 / 238				SST 01-10-046-080-05-H-1D1-0.5-J5				
	540 mm	480 mm	96	96 / 286				SST 01-10-054-096-05-H-1D1-0.5-J5				
	620 mm	560 mm	112	112 / 334				SST 01-10-062-112-05-H-1D1-0.5-J5				
	700 mm	640 mm	128	128 / 382				SST 01-10-070-128-05-H-1D1-0.5-J5				
	860 mm	800 mm	160	160 / 478				SST 01-10-086-160-05-H-1D1-0.5-J5				
	1020 mm	960 mm	192	192 / 574				SST 01-10-102-192-05-H-1D1-0.5-J5				
	1180 mm	1120 mm	224	224 / 670				SST 01-10-118-224-05-H-1D1-0.5-J5				
	1340 mm	1280 mm	256	256 / 766				SST 01-10-134-256-05-H-1D1-0.5-J5				
	1500 mm	1440 mm	288	288 / 862				SST 01-10-150-288-05-H-1D1-0.5-J5				
	1660 mm	1600 mm	320	320 / 958				SST 01-10-166-320-05-H-1D1-0.5-J5				
	1820 mm	1760 mm	352	352 / 1054				SST 01-10-182-352-05-H-1D1-0.5-J5				
	1980 mm	1920 mm	384	384 / 1150				SST 01-10-198-384-05-H-1D1-0.5-J5				
	160 mm	75 mm	8	8 / 22				10 mm		-	-	SST 01-10-016-008-10-H-1D1-0.5-J5
	220 mm	155 mm	16	16 / 46								SST 01-10-022-016-10-H-1D1-0.5-J5
	300 mm	235 mm	24	24 / 70								SST 01-10-030-024-10-H-1D1-0.5-J5
	380 mm	315 mm	32	32 / 94	SST 01-10-038-032-10-H-1D1-0.5-J5							
	460 mm	395 mm	40	40 / 118	SST 01-10-046-040-10-H-1D1-0.5-J5							
	540 mm	475 mm	48	48 / 142	SST 01-10-054-048-10-H-1D1-0.5-J5							
	620 mm	555 mm	56	56 / 166	SST 01-10-062-056-10-H-1D1-0.5-J5							
	700 mm	635 mm	64	64 / 190	SST 01-10-070-064-10-H-1D1-0.5-J5							
	860 mm	795 mm	80	80 / 238	SST 01-10-086-080-10-H-1D1-0.5-J5							
	1020 mm	955 mm	96	96 / 286	SST 01-10-102-096-10-H-1D1-0.5-J5							
	1180 mm	1115 mm	112	112 / 334	SST 01-10-118-112-10-H-1D1-0.5-J5							
	1340 mm	1275 mm	128	128 / 382	SST 01-10-134-128-10-H-1D1-0.5-J5							
	1500 mm	1435 mm	144	144 / 430	SST 01-10-150-144-10-H-1D1-0.5-J5							
	1660 mm	1595 mm	160	160 / 478	SST 01-10-166-160-10-H-1D1-0.5-J5							
	1820 mm	1755 mm	176	176 / 526	SST 01-10-182-176-10-H-1D1-0.5-J5							
	1980 mm	1915 mm	192	192 / 574	SST 01-10-198-192-10-H-1D1-0.5-J5							
	160 mm	65 mm	4	4 / 10	20 mm	-	-					SST 01-10-016-004-20-H-1D1-0.5-J5
	220 mm	145 mm	8	8 / 22								SST 01-10-022-008-20-H-1D1-0.5-J5
	300 mm	225 mm	12	12 / 34								SST 01-10-030-012-20-H-1D1-0.5-J5
	380 mm	305 mm	16	16 / 46				SST 01-10-038-016-20-H-1D1-0.5-J5				
	460 mm	385 mm	20	20 / 58				SST 01-10-046-020-20-H-1D1-0.5-J5				
	540 mm	465 mm	24	24 / 70				SST 01-10-054-024-20-H-1D1-0.5-J5				
	620 mm	545 mm	28	28 / 82				SST 01-10-062-028-20-H-1D1-0.5-J5				
	700 mm	625 mm	32	32 / 94				SST 01-10-070-032-20-H-1D1-0.5-J5				
	860 mm	785 mm	40	40 / 118				SST 01-10-086-040-20-H-1D1-0.5-J5				
	1020 mm	945 mm	48	48 / 142				SST 01-10-102-048-20-H-1D1-0.5-J5				
	1180 mm	1105 mm	56	56 / 166				SST 01-10-118-056-20-H-1D1-0.5-J5				
	1340 mm	1265 mm	64	64 / 190				SST 01-10-134-064-20-H-1D1-0.5-J5				
	1500 mm	1425 mm	72	72 / 214				SST 01-10-150-072-20-H-1D1-0.5-J5				
1660 mm	1585 mm	80	80 / 238	SST 01-10-166-080-20-H-1D1-0.5-J5								
1820 mm	1745 mm	88	88 / 262	SST 01-10-182-088-20-H-1D1-0.5-J5								
1980 mm	1905 mm	96	96 / 286	SST 01-10-198-096-20-H-1D1-0.5-J5								

Note: Special lengths are available upon request.

Available Types

	Housing Length	Active Length	Number of Channels	Number of Beams Parallel / Cross	Channel Spacing	Connection		0.5 m cable with 8 pin, M12 plug	Range			
							Output					
Receiver	160 mm	80 mm	16	16 / 46	5 mm	Solid State Relay	LO (NC)	SSR 01-4-016-016-05-H-1D1-0.5-J8	0-4 m			
	220 mm	160 mm	32	32 / 94				SSR 01-4-022-032-05-H-1D1-0.5-J8				
	300 mm	240 mm	48	48 / 142				SSR 01-4-030-048-05-H-1D1-0.5-J8				
	380 mm	320 mm	64	64 / 190				SSR 01-4-038-064-05-H-1D1-0.5-J8				
	460 mm	400 mm	80	80 / 238				SSR 01-4-046-080-05-H-1D1-0.5-J8				
	540 mm	480 mm	96	96 / 286				SSR 01-4-054-096-05-H-1D1-0.5-J8				
	620 mm	560 mm	112	112 / 334				SSR 01-4-062-112-05-H-1D1-0.5-J8				
	700 mm	640 mm	128	128 / 382				SSR 01-4-070-128-05-H-1D1-0.5-J8				
	860 mm	800 mm	160	160 / 478				SSR 01-4-086-160-05-H-1D1-0.5-J8				
	1020 mm	960 mm	192	192 / 574				SSR 01-4-102-192-05-H-1D1-0.5-J8				
	1180 mm	1120 mm	224	224 / 670				SSR 01-4-118-224-05-H-1D1-0.5-J8				
	1340 mm	1280 mm	256	256 / 766				SSR 01-4-134-256-05-H-1D1-0.5-J8				
	1500 mm	1440 mm	288	288 / 862				SSR 01-4-150-288-05-H-1D1-0.5-J8				
	1660 mm	1600 mm	320	320 / 958				SSR 01-4-166-320-05-H-1D1-0.5-J8				
	1820 mm	1760 mm	352	352 / 1054				SSR 01-4-182-352-05-H-1D1-0.5-J8				
	1980 mm	1920 mm	384	384 / 1150				SSR 01-4-198-384-05-H-1D1-0.5-J8				
	160 mm	75 mm	8	8 / 22				10 mm		Solid State Relay	LO (NC)	SSR 01-4-016-008-10-H-1D1-0.5-J8
	220 mm	155 mm	16	16 / 46								SSR 01-4-022-016-10-H-1D1-0.5-J8
	300 mm	235 mm	24	24 / 70	SSR 01-4-030-024-10-H-1D1-0.5-J8							
	380 mm	315 mm	32	32 / 94	SSR 01-4-038-032-10-H-1D1-0.5-J8							
	460 mm	395 mm	40	40 / 118	SSR 01-4-046-040-10-H-1D1-0.5-J8							
	540 mm	475 mm	48	48 / 142	SSR 01-4-054-048-10-H-1D1-0.5-J8							
	620 mm	555 mm	56	56 / 166	SSR 01-4-062-056-10-H-1D1-0.5-J8							
	700 mm	635 mm	64	64 / 190	SSR 01-4-070-064-10-H-1D1-0.5-J8							
	860 mm	795 mm	80	80 / 238	SSR 01-4-086-080-10-H-1D1-0.5-J8							
	1020 mm	955 mm	96	96 / 286	SSR 01-4-102-096-10-H-1D1-0.5-J8							
	1180 mm	1115 mm	112	112 / 334	SSR 01-4-118-112-10-H-1D1-0.5-J8							
	1340 mm	1275 mm	128	128 / 382	SSR 01-4-134-128-10-H-1D1-0.5-J8							
	1500 mm	1435 mm	144	144 / 430	SSR 01-4-150-144-10-H-1D1-0.5-J8							
	1660 mm	1595 mm	160	160 / 478	SSR 01-4-166-160-10-H-1D1-0.5-J8							
	1820 mm	1755 mm	176	176 / 526	SSR 01-4-182-176-10-H-1D1-0.5-J8							
	1980 mm	1915 mm	192	192 / 574	SSR 01-4-198-192-10-H-1D1-0.5-J8							
	160 mm	65 mm	4	4 / 10	20 mm	Solid State Relay	LO (NC)					SSR 01-4-016-004-20-H-1D1-0.5-J8
	220 mm	145 mm	8	8 / 22								SSR 01-4-022-008-20-H-1D1-0.5-J8
	300 mm	225 mm	12	12 / 34				SSR 01-4-030-012-20-H-1D1-0.5-J8				
	380 mm	305 mm	16	16 / 46				SSR 01-4-038-016-20-H-1D1-0.5-J8				
	460 mm	385 mm	20	20 / 58				SSR 01-4-046-020-20-H-1D1-0.5-J8				
	540 mm	465 mm	24	24 / 70				SSR 01-4-054-024-20-H-1D1-0.5-J8				
	620 mm	545 mm	28	28 / 82				SSR 01-4-062-028-20-H-1D1-0.5-J8				
	700 mm	625 mm	32	32 / 94				SSR 01-4-070-032-20-H-1D1-0.5-J8				
	860 mm	785 mm	40	40 / 118				SSR 01-4-086-040-20-H-1D1-0.5-J8				
	1020 mm	945 mm	48	48 / 142				SSR 01-4-102-048-20-H-1D1-0.5-J8				
	1180 mm	1105 mm	56	56 / 166				SSR 01-4-118-056-20-H-1D1-0.5-J8				
	1340 mm	1265 mm	64	64 / 190				SSR 01-4-134-064-20-H-1D1-0.5-J8				
	1500 mm	1425 mm	72	72 / 214				SSR 01-4-150-072-20-H-1D1-0.5-J8				
1660 mm	1585 mm	80	80 / 238	SSR 01-4-166-080-20-H-1D1-0.5-J8								
1820 mm	1745 mm	88	88 / 262	SSR 01-4-182-088-20-H-1D1-0.5-J8								
1980 mm	1905 mm	96	96 / 286	SSR 01-4-198-096-20-H-1D1-0.5-J8								

Note: Special lengths are available upon request.

Available Types

	Housing Length	Active Length	Number of Channels	Number of Beams Parallel / Cross	Channel Spacing	Connection		0.5 m cable with 8 pin, M12 plug	Range			
							Output			Order Reference		
Receiver	160 mm	80 mm	16	16 / 46	5 mm	Solid State Relay	LO (NC)	SSR 01-10-016-016-05-H-1D1-0.5-J8	1-10 m			
	220 mm	160 mm	32	32 / 94				SSR 01-10-022-032-05-H-1D1-0.5-J8				
	300 mm	240 mm	48	48 / 142				SSR 01-10-030-048-05-H-1D1-0.5-J8				
	380 mm	320 mm	64	64 / 190				SSR 01-10-038-064-05-H-1D1-0.5-J8				
	460 mm	400 mm	80	80 / 238				SSR 01-10-046-080-05-H-1D1-0.5-J8				
	540 mm	480 mm	96	96 / 286				SSR 01-10-054-096-05-H-1D1-0.5-J8				
	620 mm	560 mm	112	112 / 334				SSR 01-10-062-112-05-H-1D1-0.5-J8				
	700 mm	640 mm	128	128 / 382				SSR 01-10-070-128-05-H-1D1-0.5-J8				
	860 mm	800 mm	160	160 / 478				SSR 01-10-086-160-05-H-1D1-0.5-J8				
	1020 mm	960 mm	192	192 / 574				SSR 01-10-102-192-05-H-1D1-0.5-J8				
	1180 mm	1120 mm	224	224 / 670				SSR 01-10-118-224-05-H-1D1-0.5-J8				
	1340 mm	1280 mm	256	256 / 766				SSR 01-10-134-256-05-H-1D1-0.5-J8				
	1500 mm	1440 mm	288	288 / 862				SSR 01-10-150-288-05-H-1D1-0.5-J8				
	1660 mm	1600 mm	320	320 / 958				SSR 01-10-166-320-05-H-1D1-0.5-J8				
	1820 mm	1760 mm	352	352 / 1054				SSR 01-10-182-352-05-H-1D1-0.5-J8				
	1980 mm	1920 mm	384	384 / 1150				SSR 01-10-198-384-05-H-1D1-0.5-J8				
	160 mm	75 mm	8	8 / 22				10 mm		Solid State Relay	LO (NC)	SSR 01-10-016-008-10-H-1D1-0.5-J8
	220 mm	155 mm	16	16 / 46								SSR 01-10-022-016-10-H-1D1-0.5-J8
	300 mm	235 mm	24	24 / 70	SSR 01-10-030-024-10-H-1D1-0.5-J8							
	380 mm	315 mm	32	32 / 94	SSR 01-10-038-032-10-H-1D1-0.5-J8							
	460 mm	395 mm	40	40 / 118	SSR 01-10-046-040-10-H-1D1-0.5-J8							
	540 mm	475 mm	48	48 / 142	SSR 01-10-054-048-10-H-1D1-0.5-J8							
	620 mm	555 mm	56	56 / 166	SSR 01-10-062-056-10-H-1D1-0.5-J8							
	700 mm	635 mm	64	64 / 190	SSR 01-10-070-064-10-H-1D1-0.5-J8							
	860 mm	795 mm	80	80 / 238	SSR 01-10-086-080-10-H-1D1-0.5-J8							
	1020 mm	955 mm	96	96 / 286	SSR 01-10-102-096-10-H-1D1-0.5-J8							
	1180 mm	1115 mm	112	112 / 334	SSR 01-10-118-112-10-H-1D1-0.5-J8							
	1340 mm	1275 mm	128	128 / 382	SSR 01-10-134-128-10-H-1D1-0.5-J8							
	1500 mm	1435 mm	144	144 / 430	SSR 01-10-150-144-10-H-1D1-0.5-J8							
	1660 mm	1595 mm	160	160 / 478	SSR 01-10-166-160-10-H-1D1-0.5-J8							
	1820 mm	1755 mm	176	176 / 526	SSR 01-10-182-176-10-H-1D1-0.5-J8							
	1980 mm	1915 mm	192	192 / 574	SSR 01-10-198-192-10-H-1D1-0.5-J8							
	160 mm	65 mm	4	4 / 10	20 mm	Solid State Relay	LO (NC)		SSR 01-10-016-004-20-H-1D1-0.5-J8			
	220 mm	145 mm	8	8 / 22					SSR 01-10-022-008-20-H-1D1-0.5-J8			
	300 mm	225 mm	12	12 / 34				SSR 01-10-030-012-20-H-1D1-0.5-J8				
	380 mm	305 mm	16	16 / 46				SSR 01-10-038-016-20-H-1D1-0.5-J8				
	460 mm	385 mm	20	20 / 58				SSR 01-10-046-020-20-H-1D1-0.5-J8				
	540 mm	465 mm	24	24 / 70				SSR 01-10-054-024-20-H-1D1-0.5-J8				
	620 mm	545 mm	28	28 / 82				SSR 01-10-062-028-20-H-1D1-0.5-J8				
	700 mm	625 mm	32	32 / 94				SSR 01-10-070-032-20-H-1D1-0.5-J8				
	860 mm	785 mm	40	40 / 118				SSR 01-10-086-040-20-H-1D1-0.5-J8				
	1020 mm	945 mm	48	48 / 142				SSR 01-10-102-048-20-H-1D1-0.5-J8				
	1180 mm	1105 mm	56	56 / 166				SSR 01-10-118-056-20-H-1D1-0.5-J8				
	1340 mm	1265 mm	64	64 / 190				SSR 01-10-134-064-20-H-1D1-0.5-J8				
	1500 mm	1425 mm	72	72 / 214				SSR 01-10-150-072-20-H-1D1-0.5-J8				
1660 mm	1585 mm	80	80 / 238	SSR 01-10-166-080-20-H-1D1-0.5-J8								
1820 mm	1745 mm	88	88 / 262	SSR 01-10-182-088-20-H-1D1-0.5-J8								
1980 mm	1905 mm	96	96 / 286	SSR 01-10-198-096-20-H-1D1-0.5-J8								

Note: Special lengths are available upon request.

Connections

		M12 Plug / Cable	
		SST	SSR
Supply +		Pin 1 / Brown	Pin 2 / Brown
Supply -		Pin 3 / Blue	Pin 7 / Blue
Common sync 1		Pin 2 / White	Pin 1 / White
Common sync 2		Pin 5 / Grey	Pin 5 / Grey
Test input		Pin 4 / Black	-
Output		-	Pin 3 / Green
Output		-	Pin 4 / Yellow
Parallel / Cross beams selection	Ctrl 1	-	Pin 6 / Pink
Blanking function control	Ctrl 2	-	Pin 8 / Red

5 pin, M12

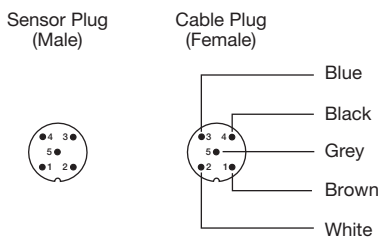

8 pin, M12

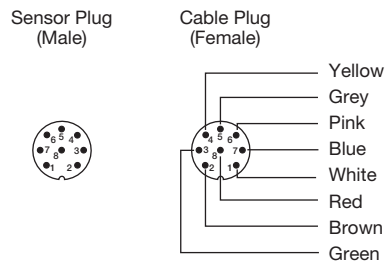

Wiring Diagrams

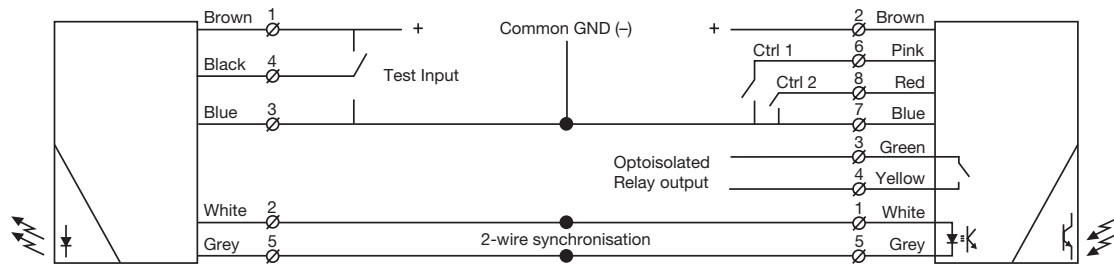

SST 01
Connect black test input wire to + or - to disable SST

SSR 01
Ctrl 1 Parallel or cross beams selection
Ctrl 2 Blanking function set-up

Dimensions and Descriptions

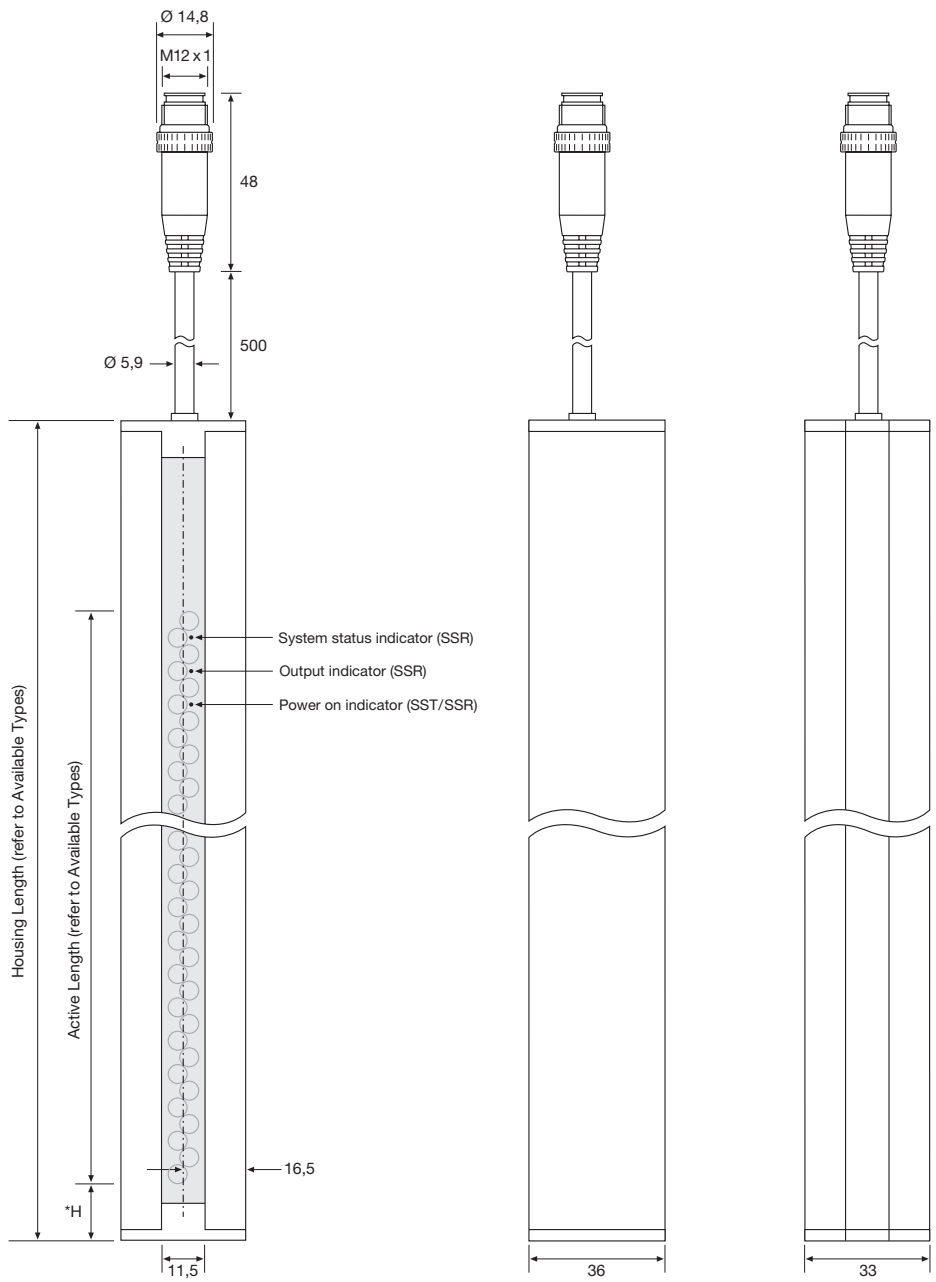

*H =
 5 mm channel spacing: 13,8 mm
 10/20 mm channel spacing: 15,8 mm

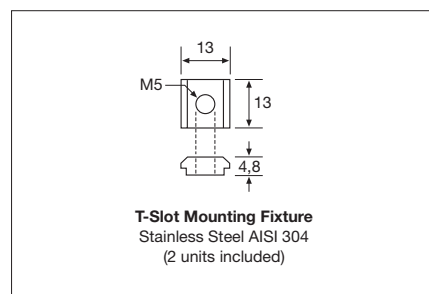
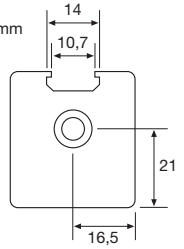

(Units in mm)

Beam Patterns

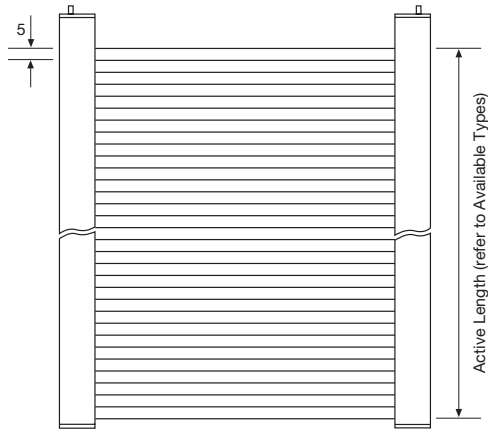

Parallel Beams

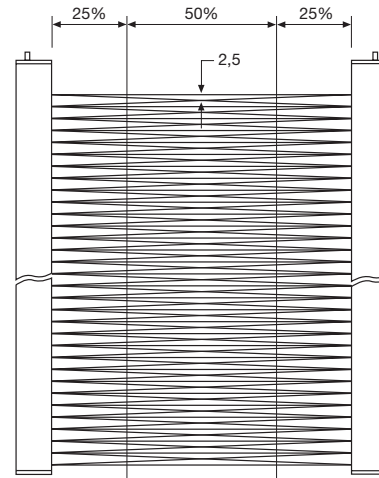

Cross Beams

5 mm channel spacing

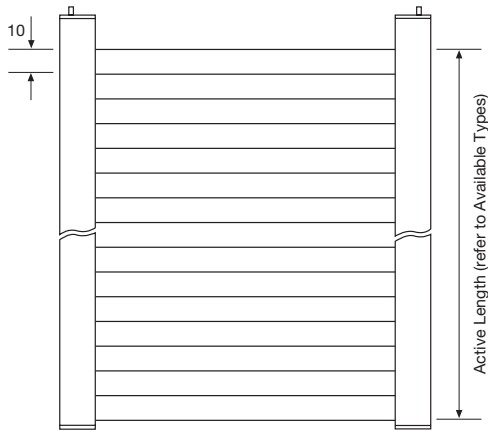

Parallel Beams

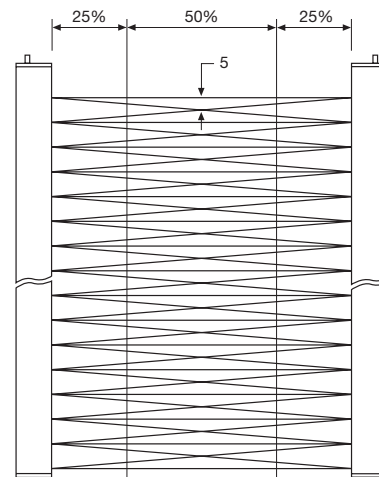

Cross Beams

10 mm channel spacing

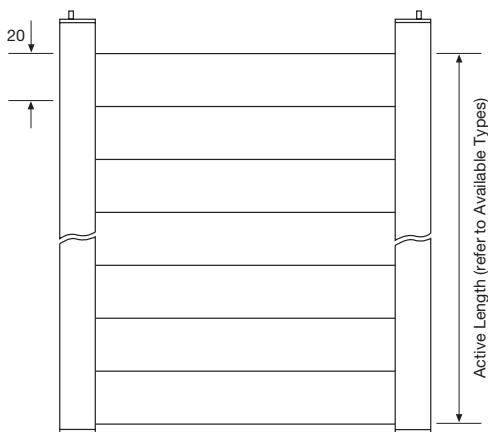

Parallel Beams

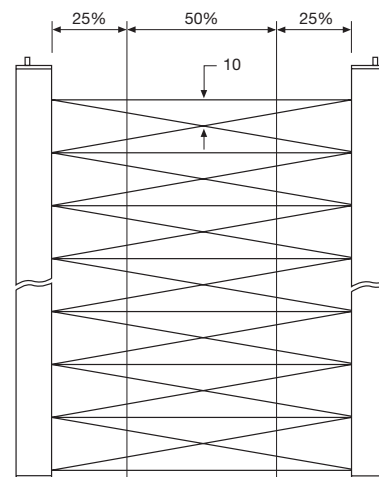

Cross Beams

20 mm channel spacing

(Units in mm)

Sensing Characteristics

Parallel Displacement

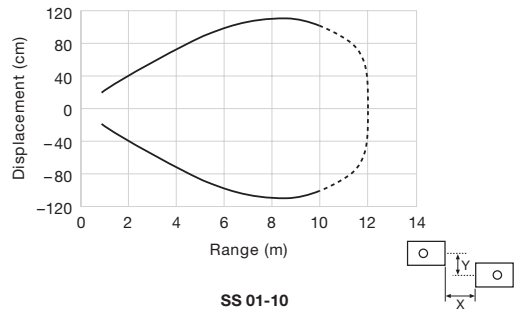
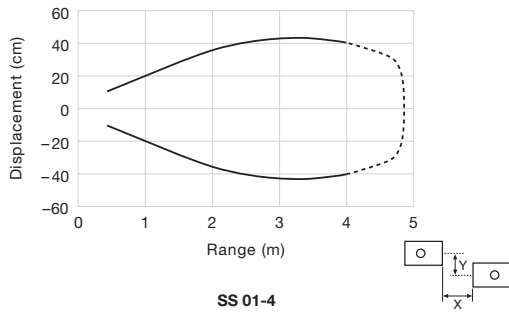

Mounting Bracket

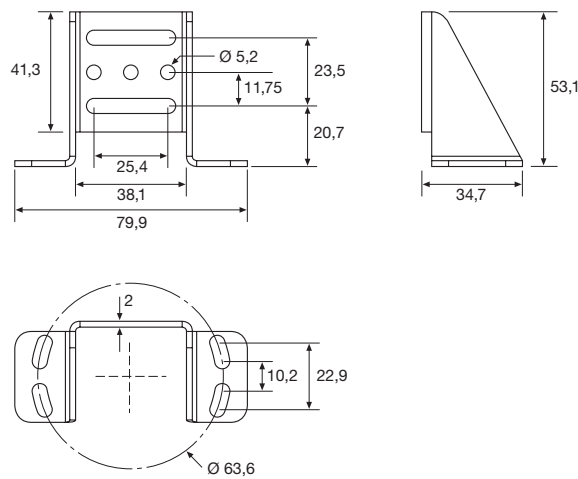

TR SS53-80 LU
Stainless Steel AISI 304
(to be ordered separately)

(Units in mm)

Telco reserves the right to change specifications without notice.